

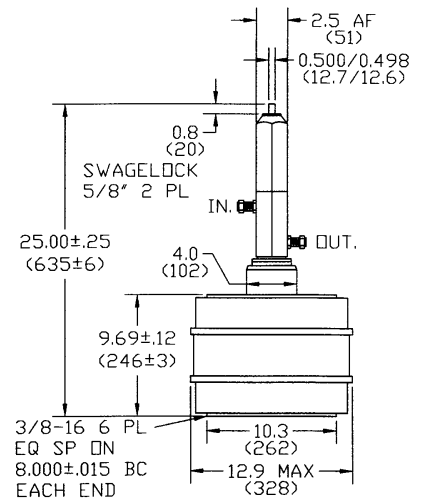

CWV4 2050 SPECIFICATIONS

Model Number	CWV4-2050-0040	CWV4-2050-0045	CWV4-2050-0050
Capacity Range (pF)	100-2050	100-2050	100-2050
Voltage (kV) Peak			
Test	40	45	50
Working	24	27	30
Current Amps (RMS) Max.	1000†	1000†	1000†
Type	Ceramic	Ceramic	Ceramic
Nominal Dimensions			
Length (in. / mm)	25.00 / 635.00	25.00 / 635.00	25.00 / 635.00
Diameter (in. / mm)	12.90 / 327.70	12.90 / 327.70	12.90 / 327.70
Torque (in Lbs.) Max.	18	18	18
Direct Pull (Lbs.) Max.	250	250	250
Weight (Nominal)	125 lb.	125 lb.	125 lb.
NOTES: <i>Mounting:</i> Both ends have tapped holes. † Water cooling.			



CAPACITY vs TURNS
Typical Data

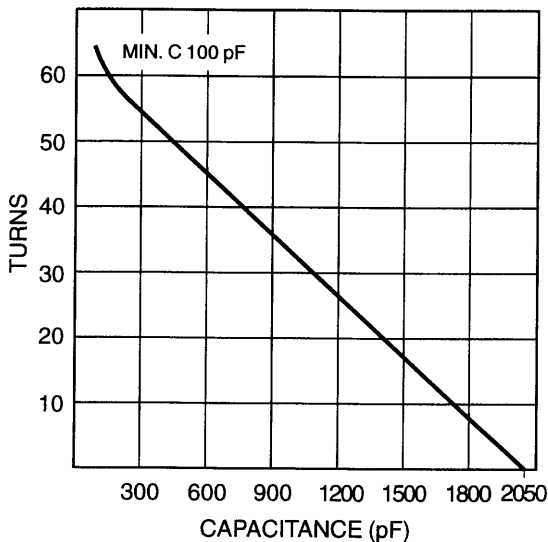

CONTINUOUS RMS AMPERES vs FREQUENCY
(at 30kV PEAK WORKING VOLTAGE)

